

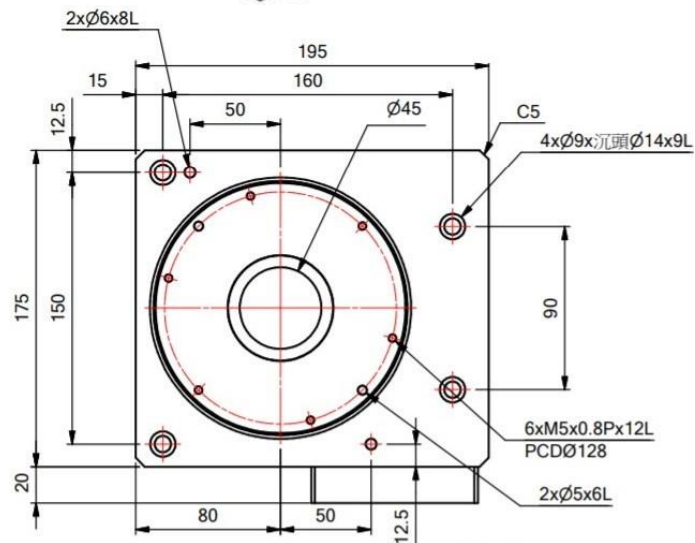

PW Hollow Rotary

The IDP-PW series hollow rotary platform adopts a worm gear design, featuring a large aperture for convenient wiring, high reduction ratio, and high torque characteristics, providing the equipment with excellent transmission advantages.

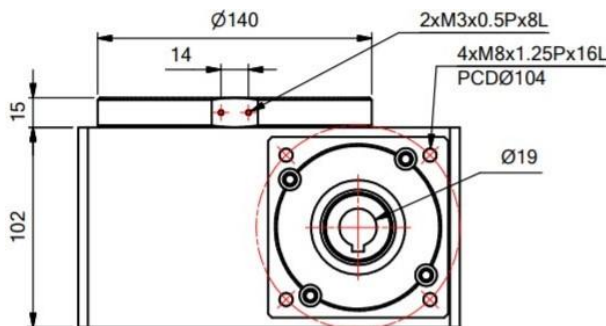
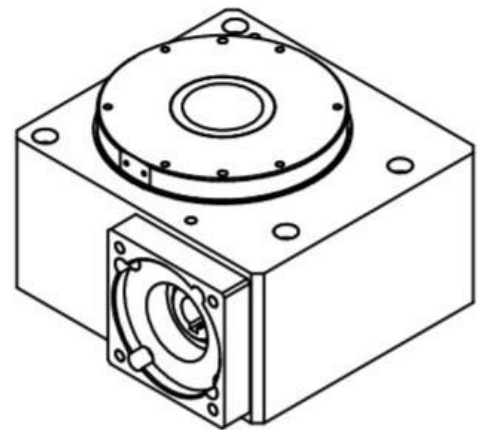

model	PW-175H
Output Configuration	Crossed roller bearings
Permissible Torque (N.m)	80
Axial Load (Hanging) (N)	1000
Disk Side Load (N)	600
Ratio	20
Maximum Input Speed (rpm)	3000
Repeatability Precision (mm)	+/- 0.02
Turntable Backlash (arc-min)	6
Weight (kg)	12



4F., No.48, Wugong 6th Rd., Wugu Dist., New Taipei City 248, Taiwan

Tel : +886- 2-2299-1556
Fax : +886- 2-2299-1881

e-mail : info@ideadesignproduction.com
www.ideadesignproduction.com